



ADDOWN REALTY

— Connecting You To Your Perfect Property —

45.00 MT WIDE ROAD

RAMP DN

SHOP-1
11'-8"X25'-7"

SHOP-2
10'X25'-7"

SHOP-3
10'X25'-7"

SHOP-4
11'-2"X25'-7"

SHOP-5
9'-3"X25'-7"

SHOP-6
10'X25'-7"

SHOP-7
12'X25'-7"

SHOP-8
12'X30'

SHOP-9
14'-7"X30'

SHOP-10
10'X30'

SHOP-11
9'-4"X30'

SHOP-12
10'X30'

SHOP-13
14'-7"X30'

(A)

LIFT

LIFT

DN

UP

(B)

DN

UP

LIFT

LIFT

COMMON
PLOT

12.00 MT WIDE ROAD

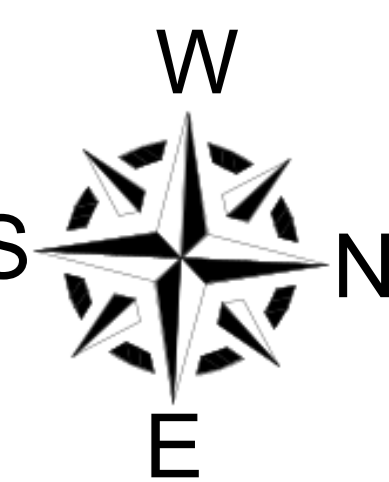

PROPOSE 3BHK APARTMENT

GROUND FLOOR PLAN



ARCHITECT
VIKRAM PANDYA AND ASSO.
DARSHAK PUNJABI HALL LANE VRANGPUR AHMEDABAD
PH NO- 079-26420632

45.00 MT WIDE ROAD



12.00 MT WIDE ROAD

COMMON PLOT

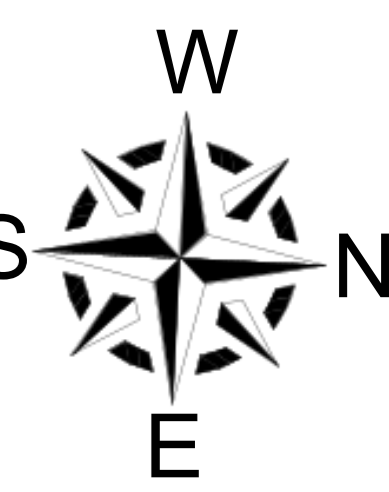

PROPOSE 3BHK APARTMENT

TYPICAL FLOOR PLAN



ARCHITECT
VIKRAMPANDYAANDASSO.
 DARSHAK PUNJABI HALL LANE, VRANGPUR, AHMEDABAD
 PH NO- 079-26420632

45.00 MT WIDE ROAD

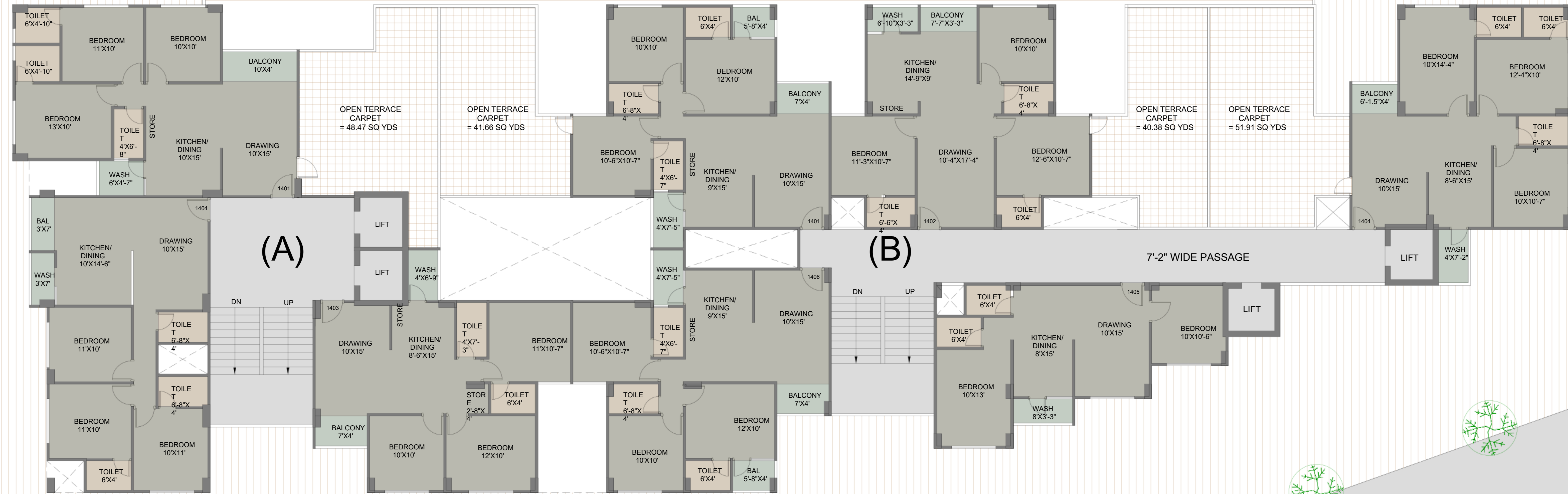

12.00 MT WIDE ROAD

COMMON PLOT

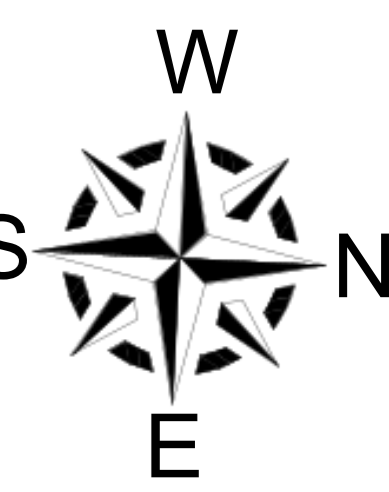

PROPOSE 3BHK APARTMENT

14TH FLOOR PLAN



ARCHITECT
VIKRAMPANDYAANDASSO.
DARSHAK PUNJABI HALL LANEVVRANGPURAHMEDABAD
PH NO- 079-26420632

45.00 MT WIDE ROAD

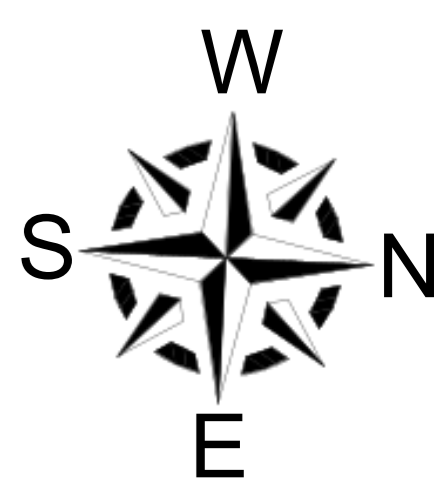
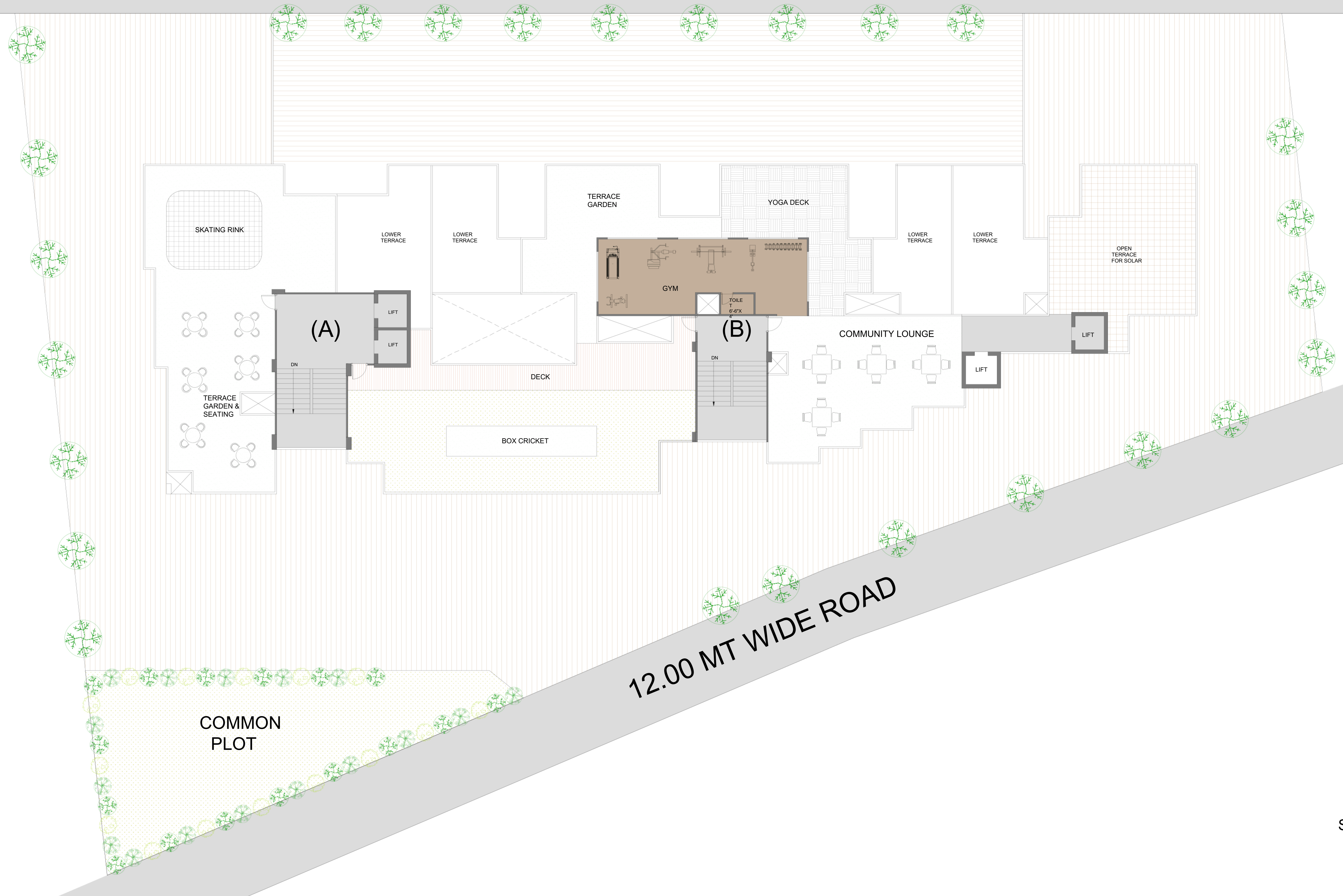

PROPOSE 3BHK APARTMENT

TERRACE PLAN



ARCHITECT
VIKRAM PANDYA AND ASSO.
DARSHAK PUNJABI HALL LANE VRANGPUR AHMEDABAD
PH NO- 079-26420632

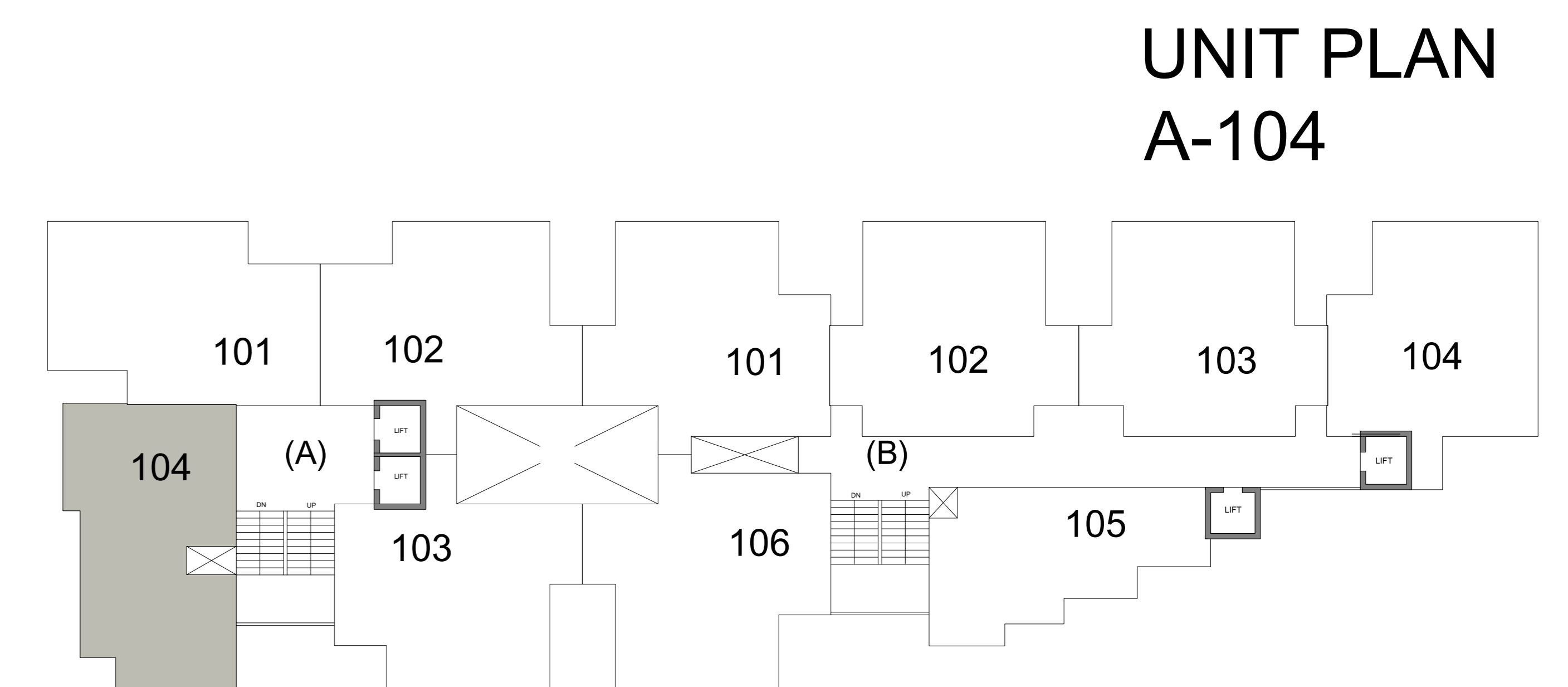
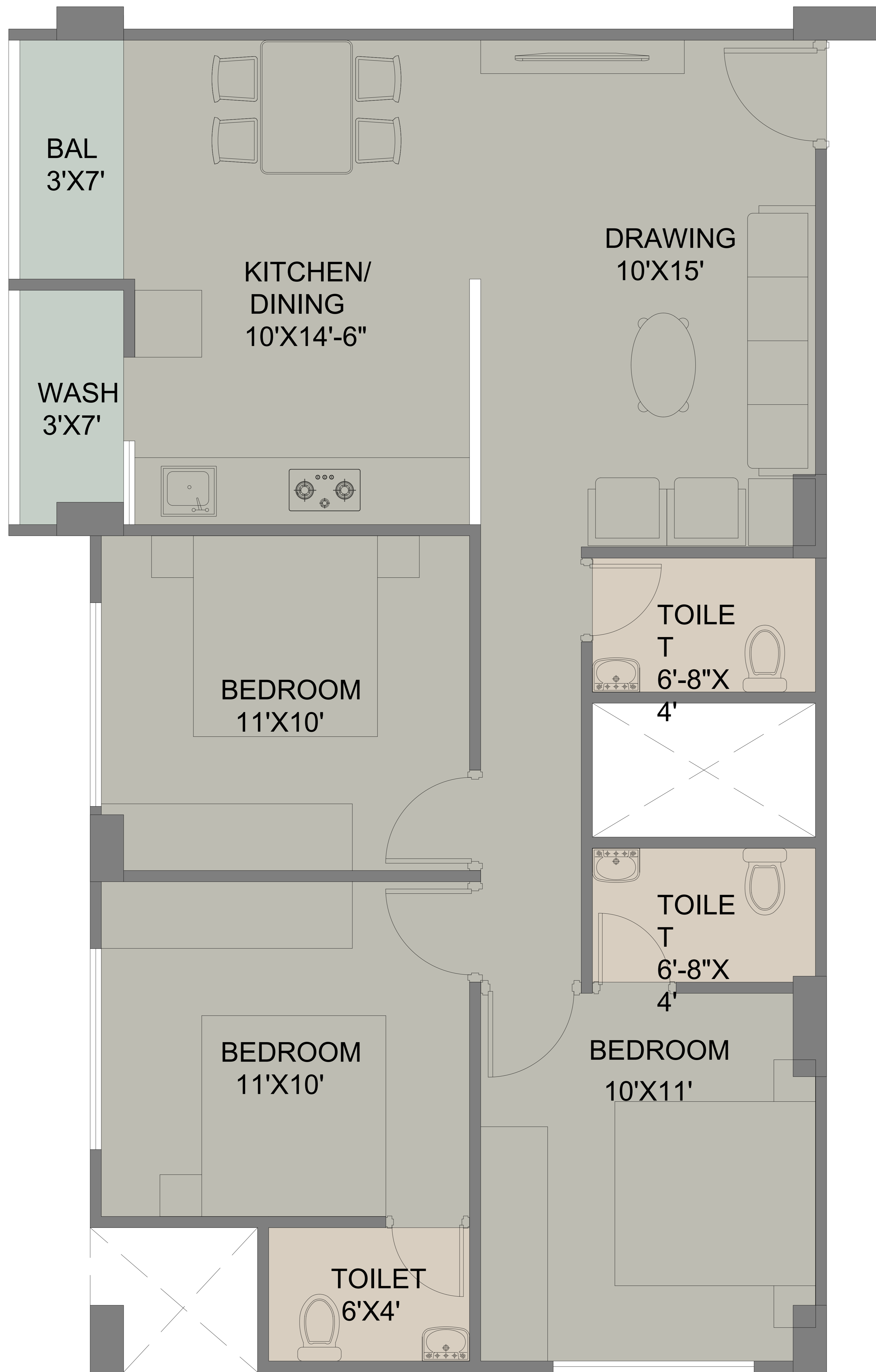

PROPOSE 3BHK APARTMENT

UNIT PLAN
A-101

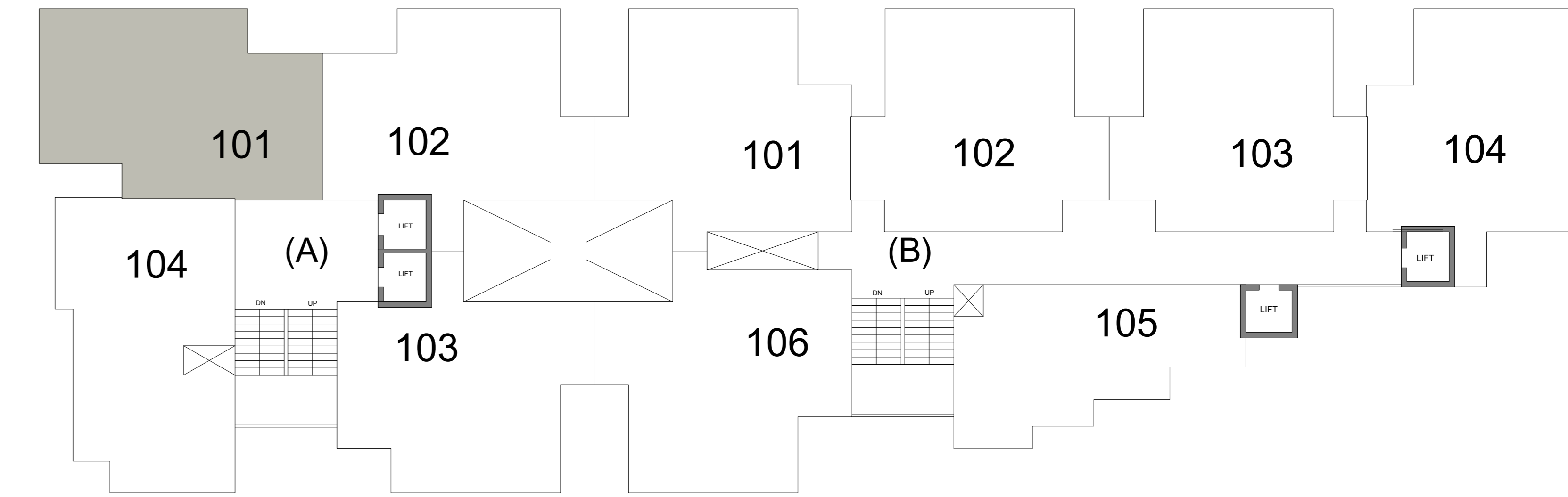

PROPOSE 3BHK APARTMENT

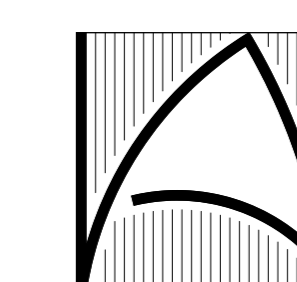

ARCHITECT
VIKRAM PANDYA AND ASSO.
DARSHAK PUNJABI HALL LANE, VRANGPUR, AHMEDABAD
PH NO- 079-26420632

UNIT PLAN
A-102

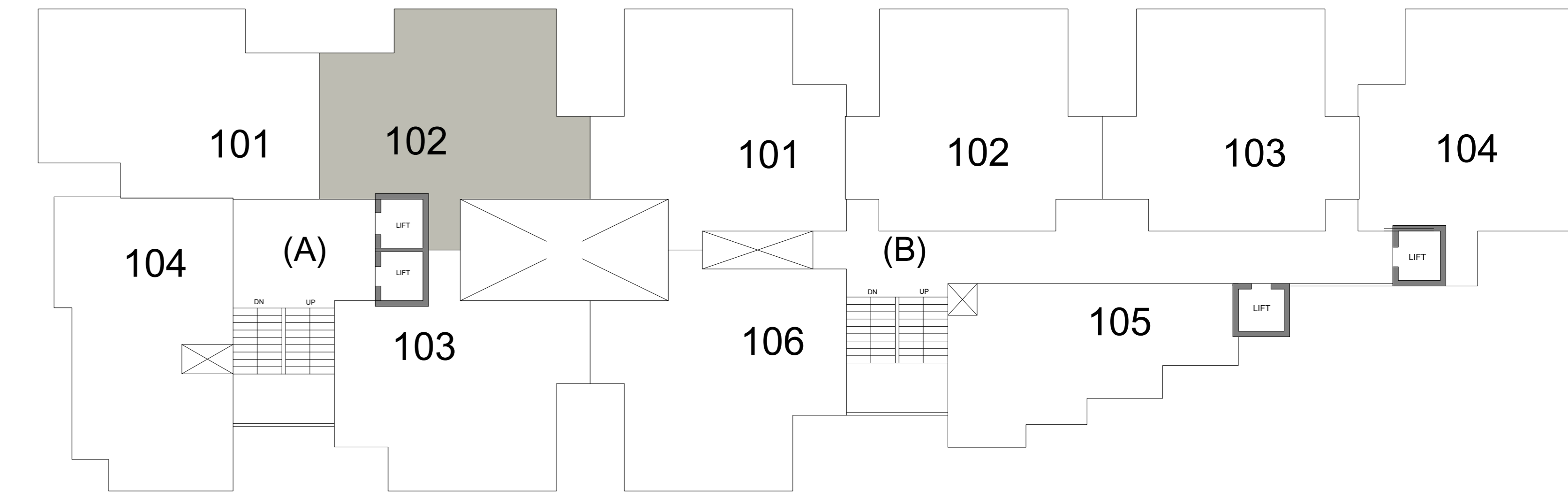

PROPOSE 3BHK APARTMENT

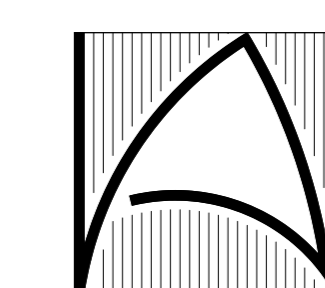

ARCHITECT
VIKRAM PANDYA AND ASSO.
DARSHAK PUNJABI HALL LANE VRANGPUR AHMEDABAD
PH NO- 079-26420632



**UNIT PLAN
A-103**

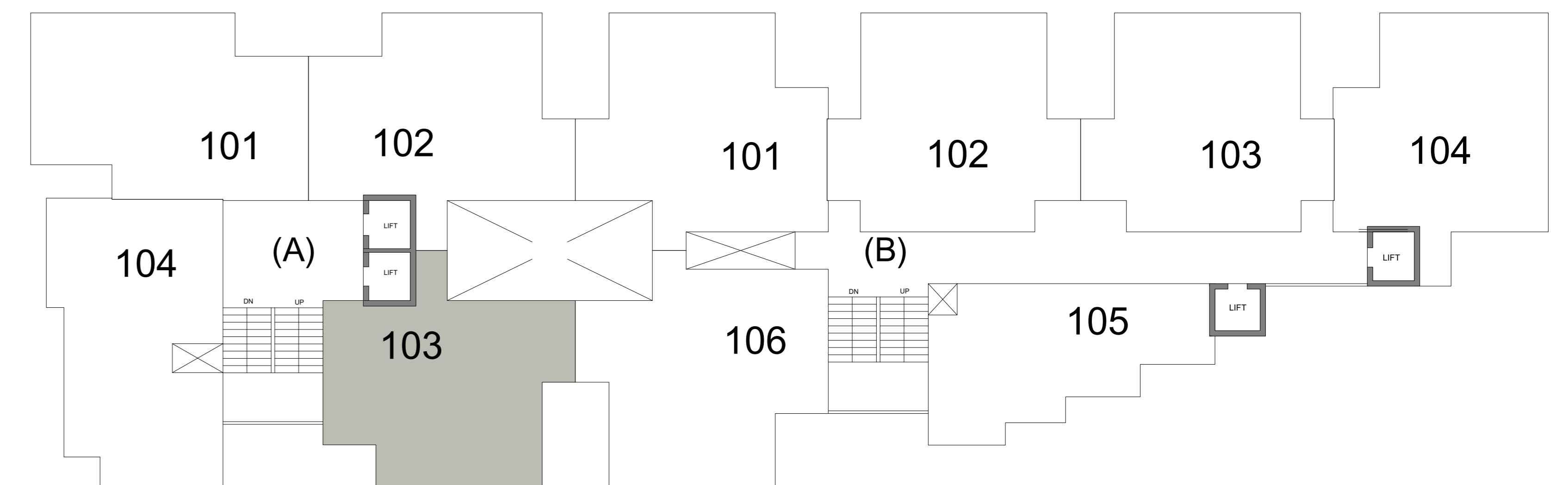

PROPOSE 3BHK APARTMENT

UNIT PLAN
B-101-106

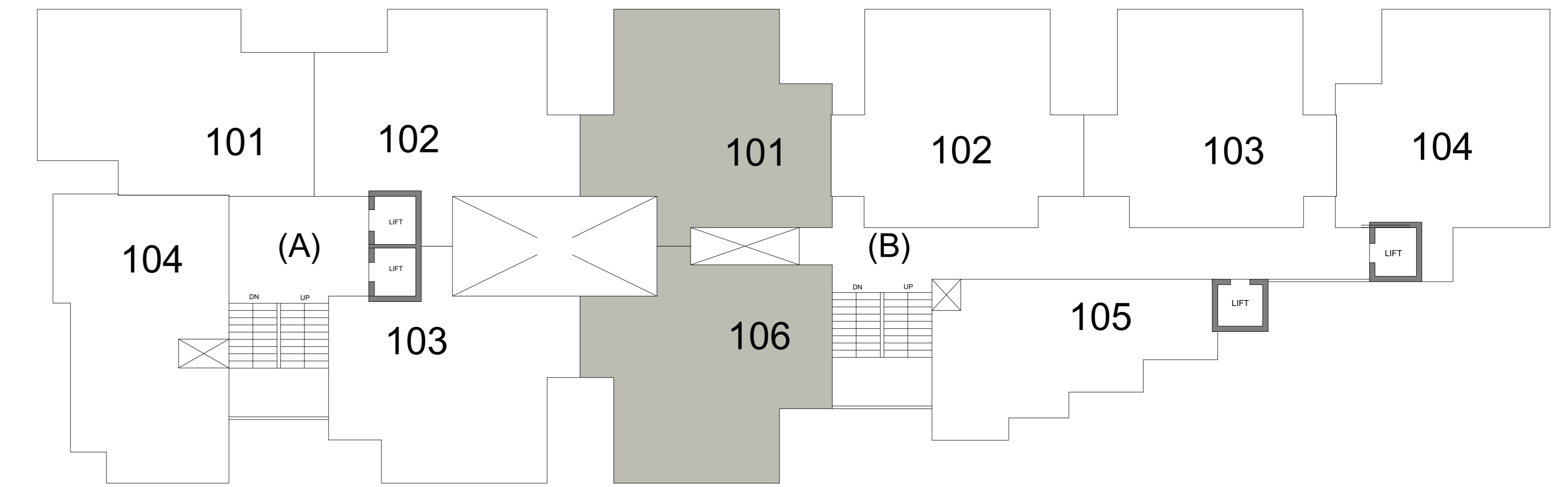

PROPOSE 3BHK APARTMENT

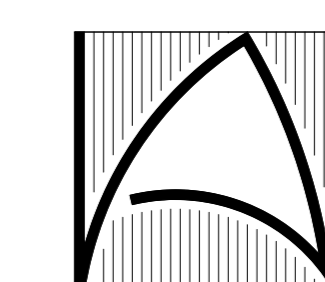

ARCHITECT
VIKRAM PANDYA AND ASSO.
DARSHAK PUNJABI HALL LANE VRANGPUR AHMEDABAD
PH NO- 079-26420632

**UNIT PLAN
B-102-103**

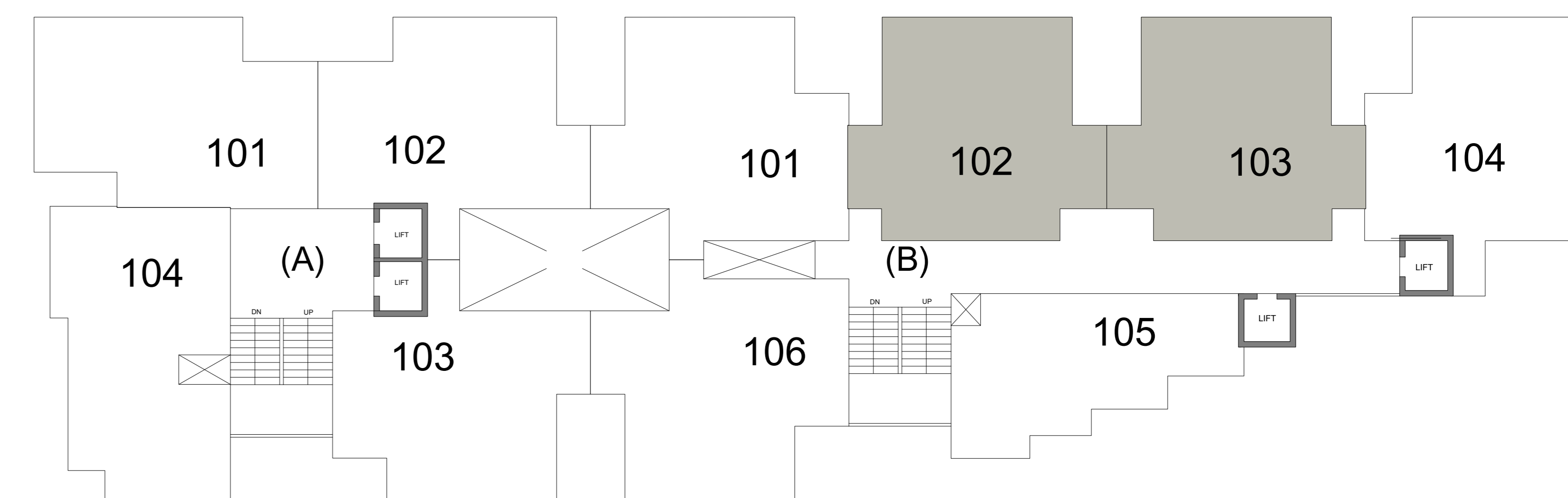

PROPOSE 3BHK APARTMENT



**UNIT PLAN
B-104**

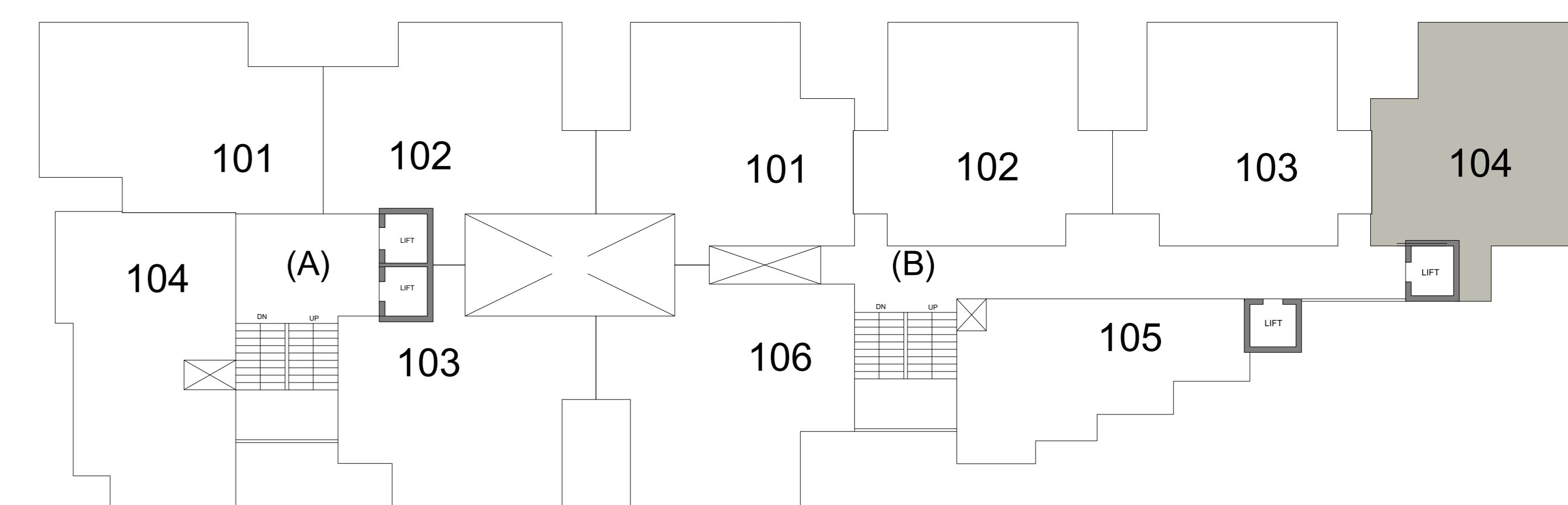

PROPOSE 3BHK APARTMENT

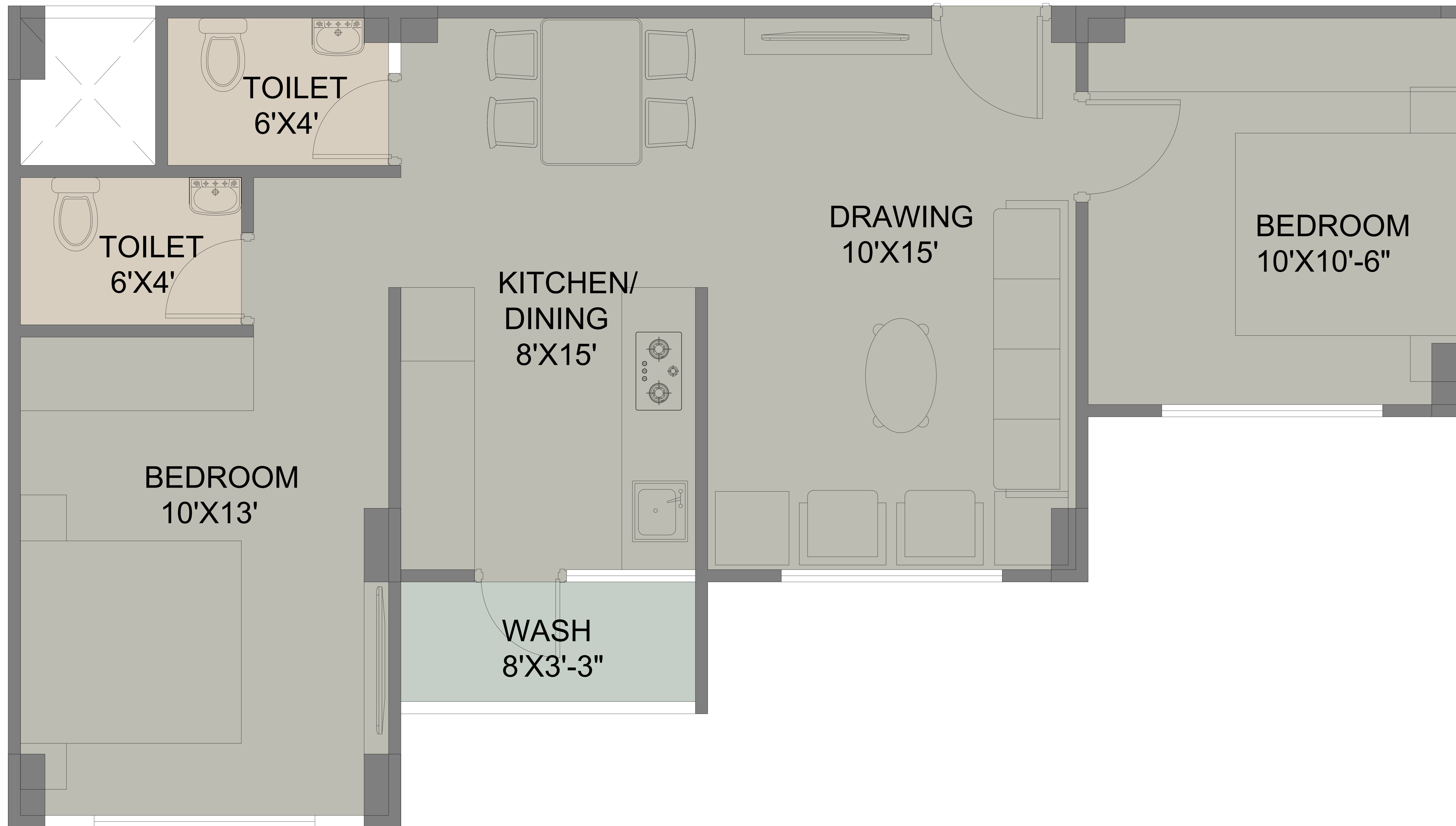

**UNIT PLAN
B-105**

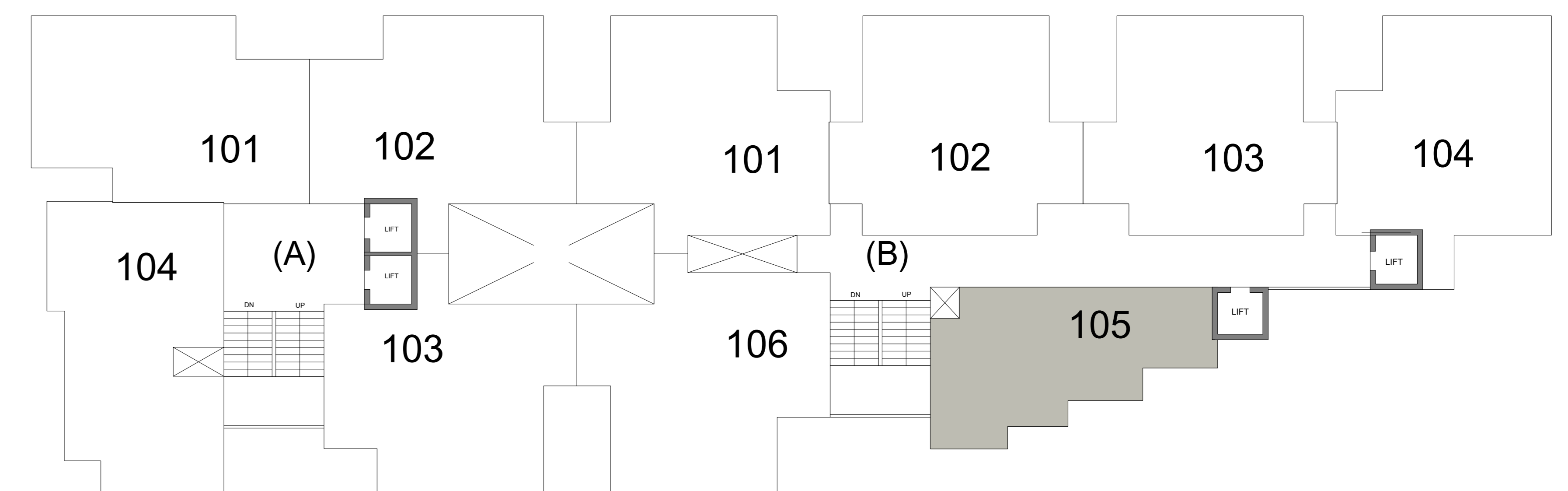

PROPOSE 3BHK APARTMENT